

"DOCCE FLAT D" mod. XG1 - Con profili esterni per installazioni su qualsiasi tipo di piatto esistente oppure su pavimento finito / With external profiles for installation on finished floor or any type of shower tray

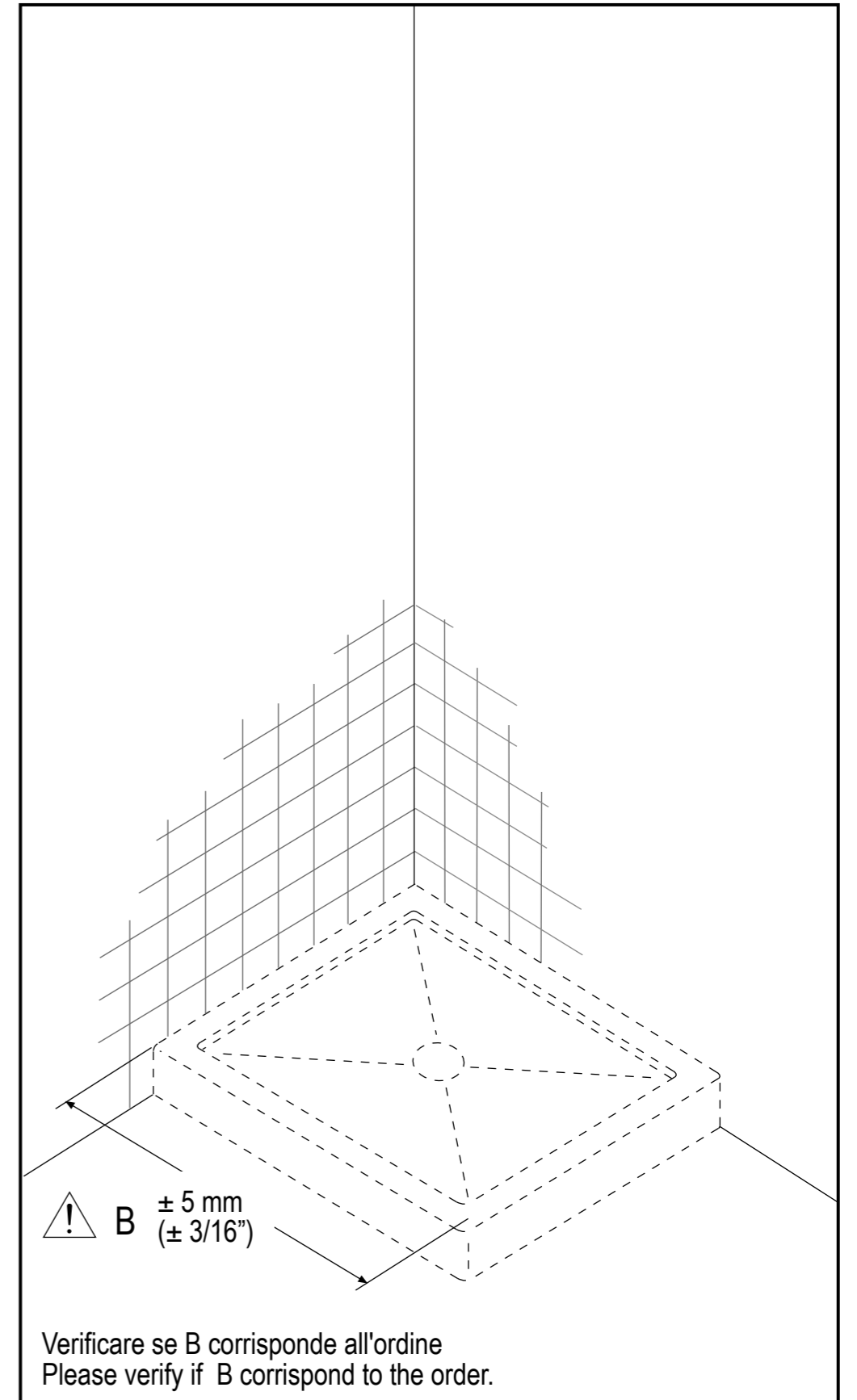

Strumenti /  
Instruments

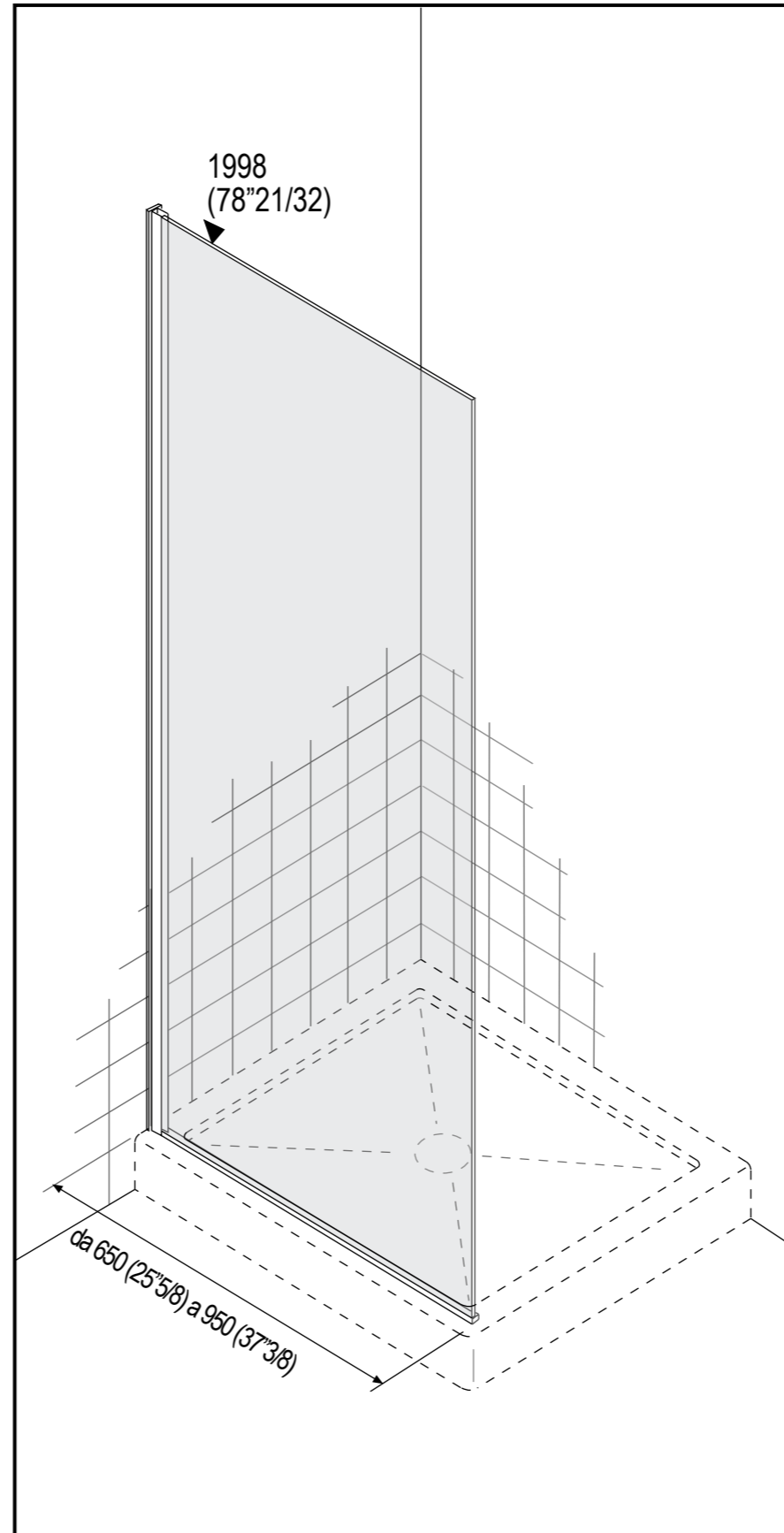
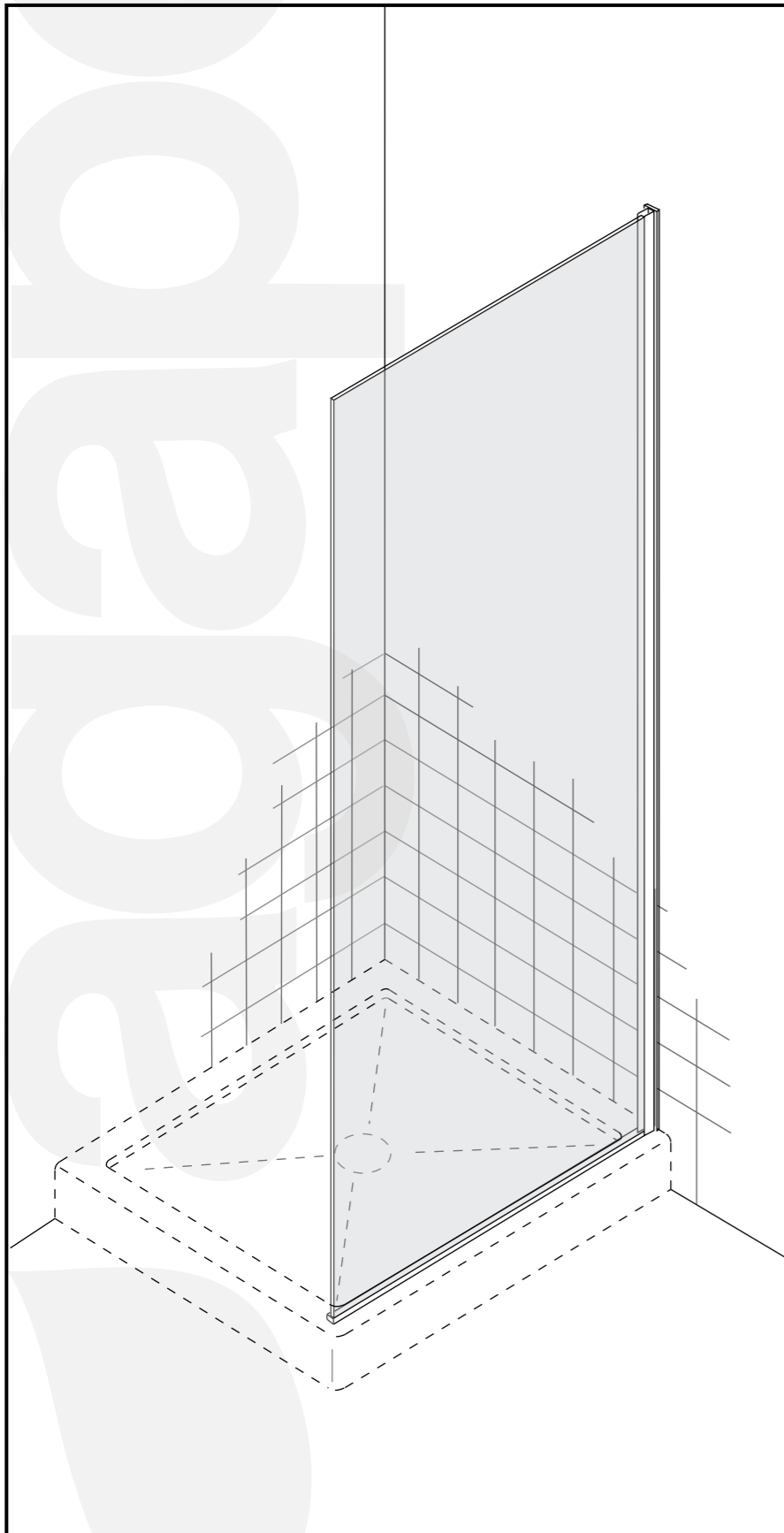
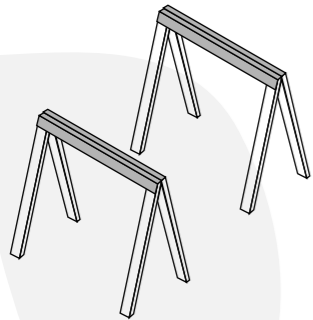
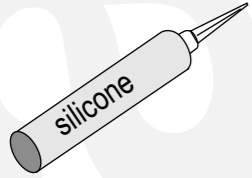
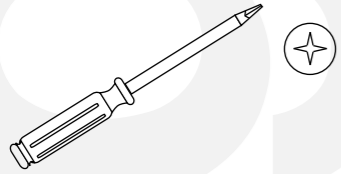
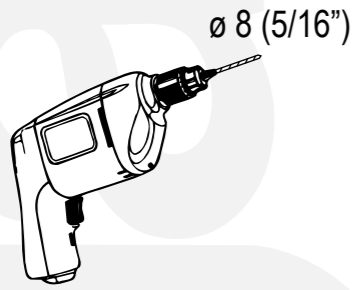
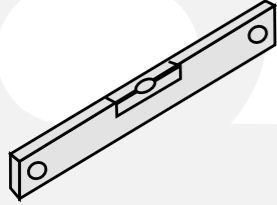

Fianco / side panel - Esploso / pre - assembled

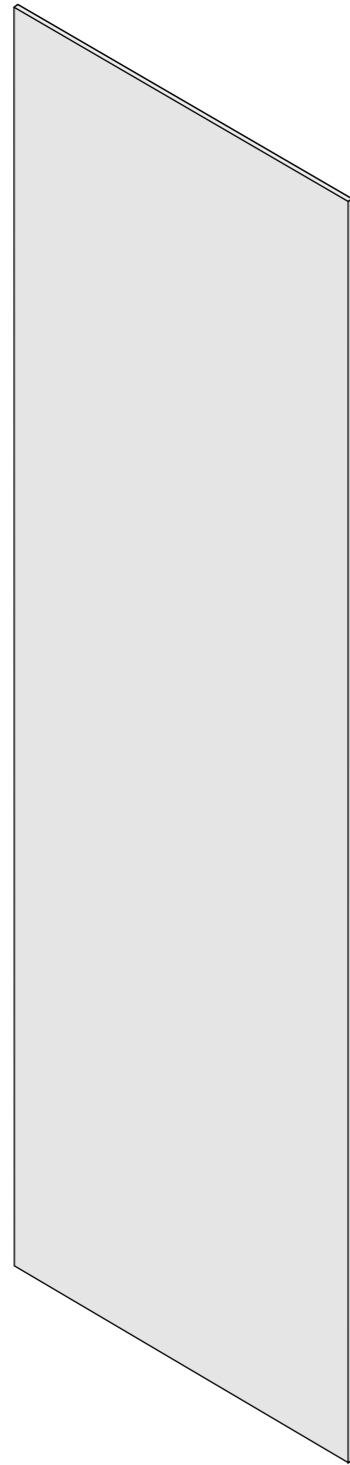

(a) n°1



(b) n°1

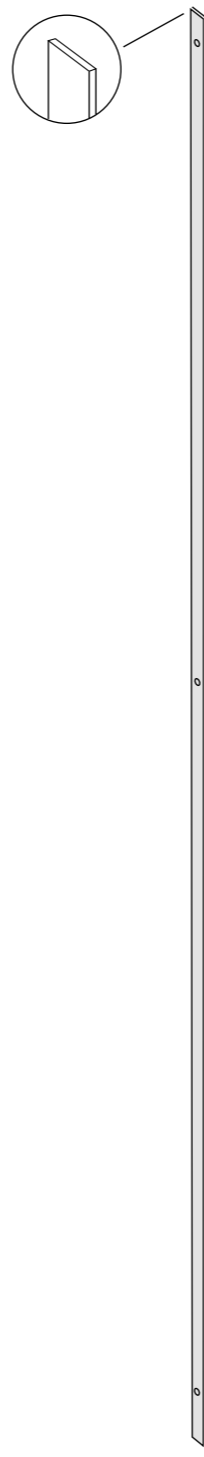

(c) n°1



(d) n°2

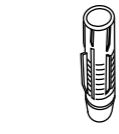

(e) n°3

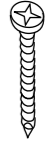

(f) n°3



(g) n°2

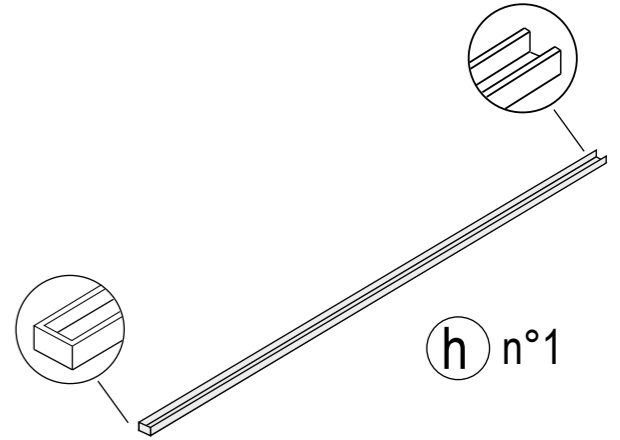

(h) n°1

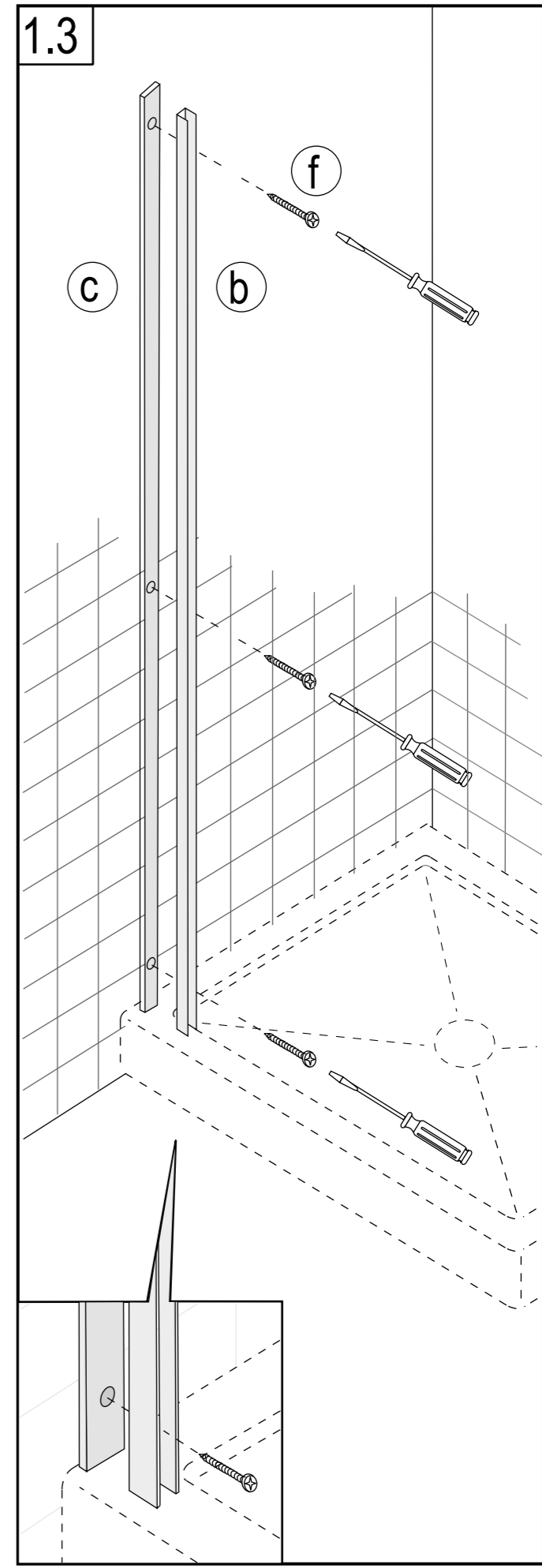
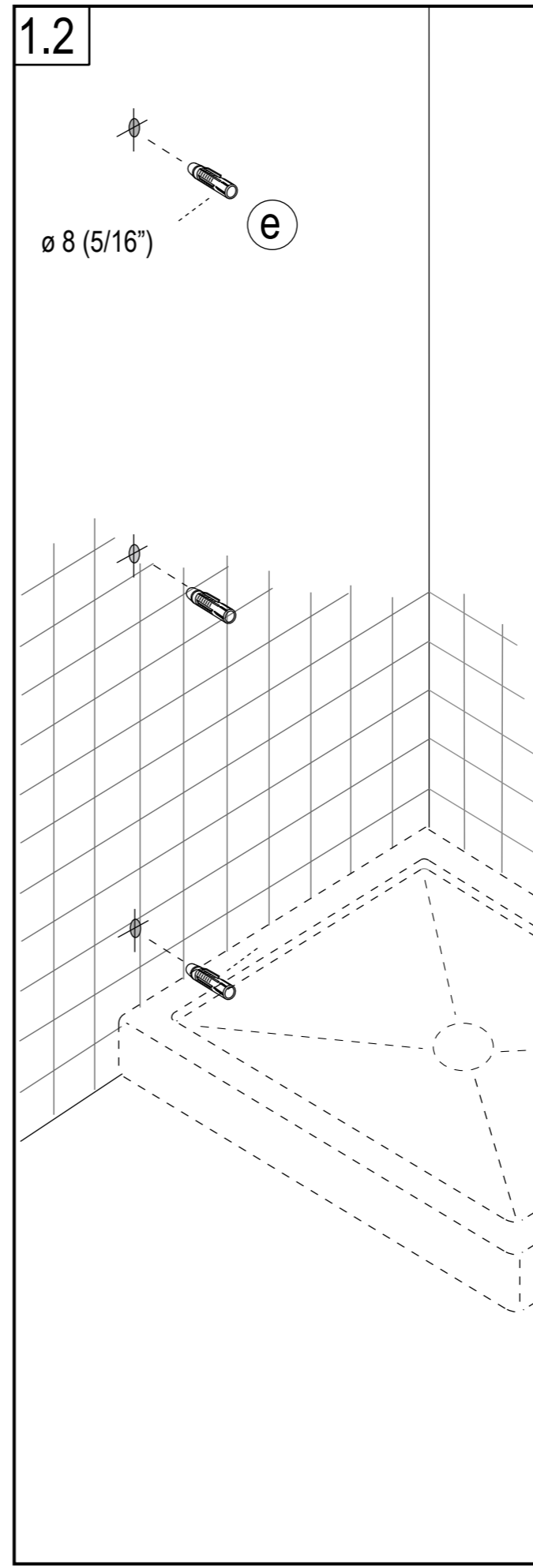
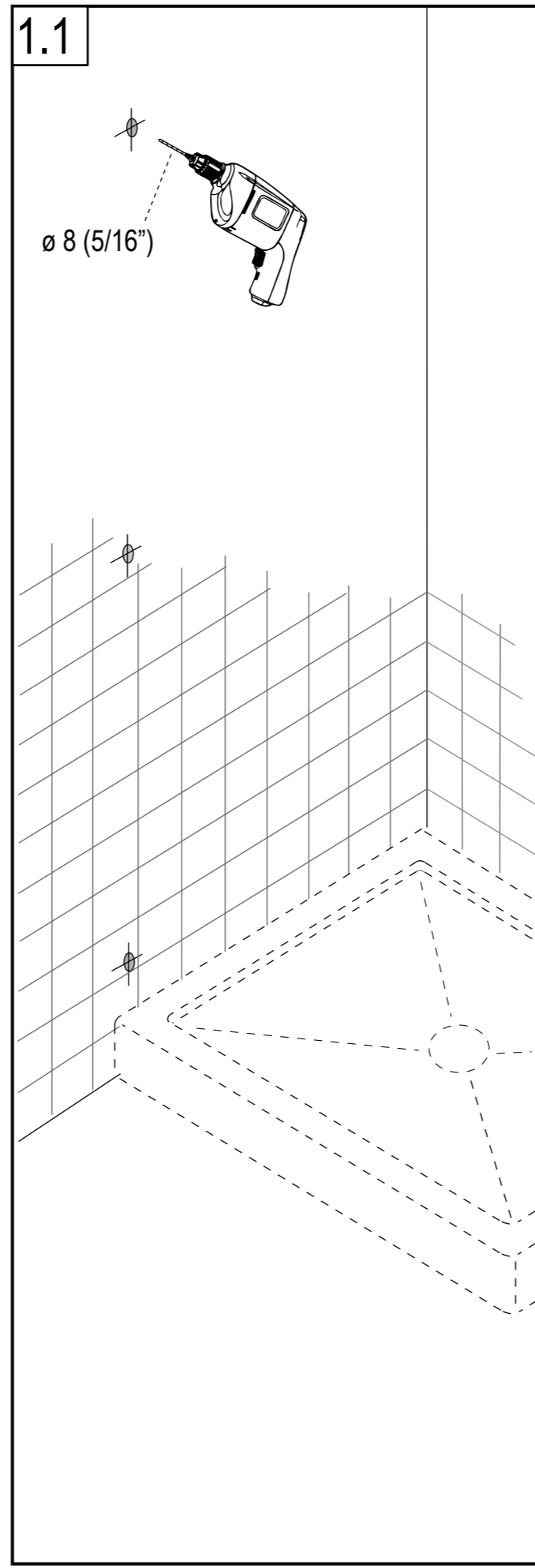
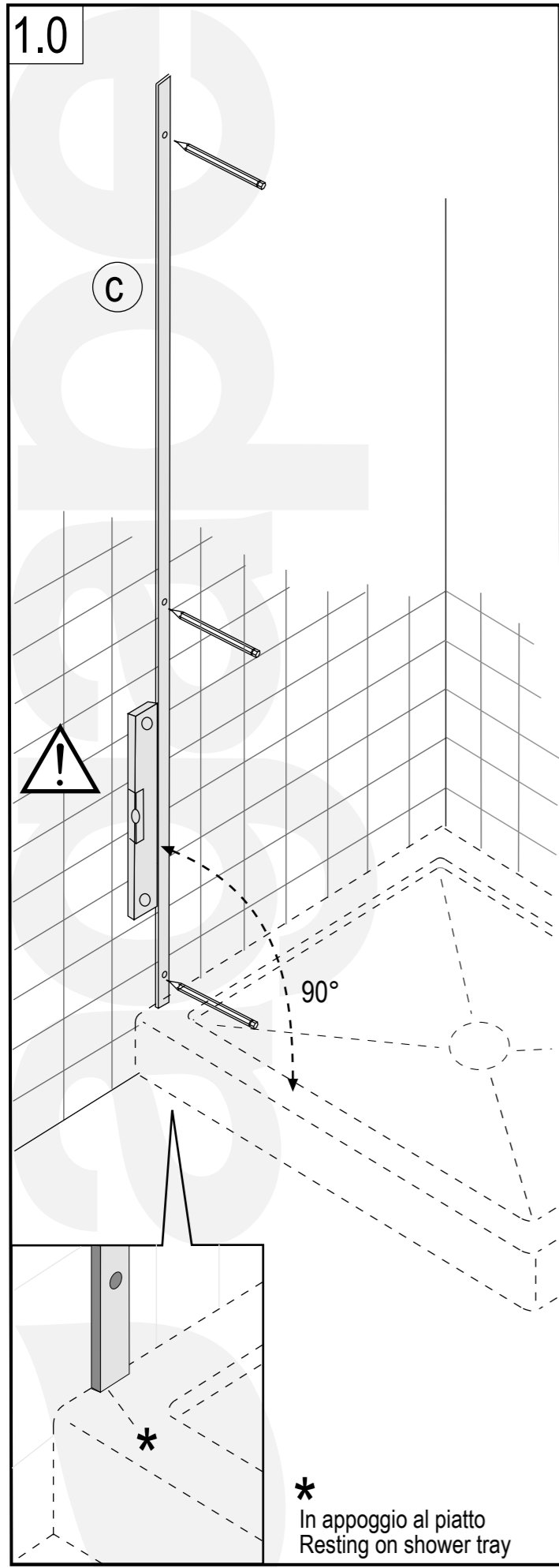

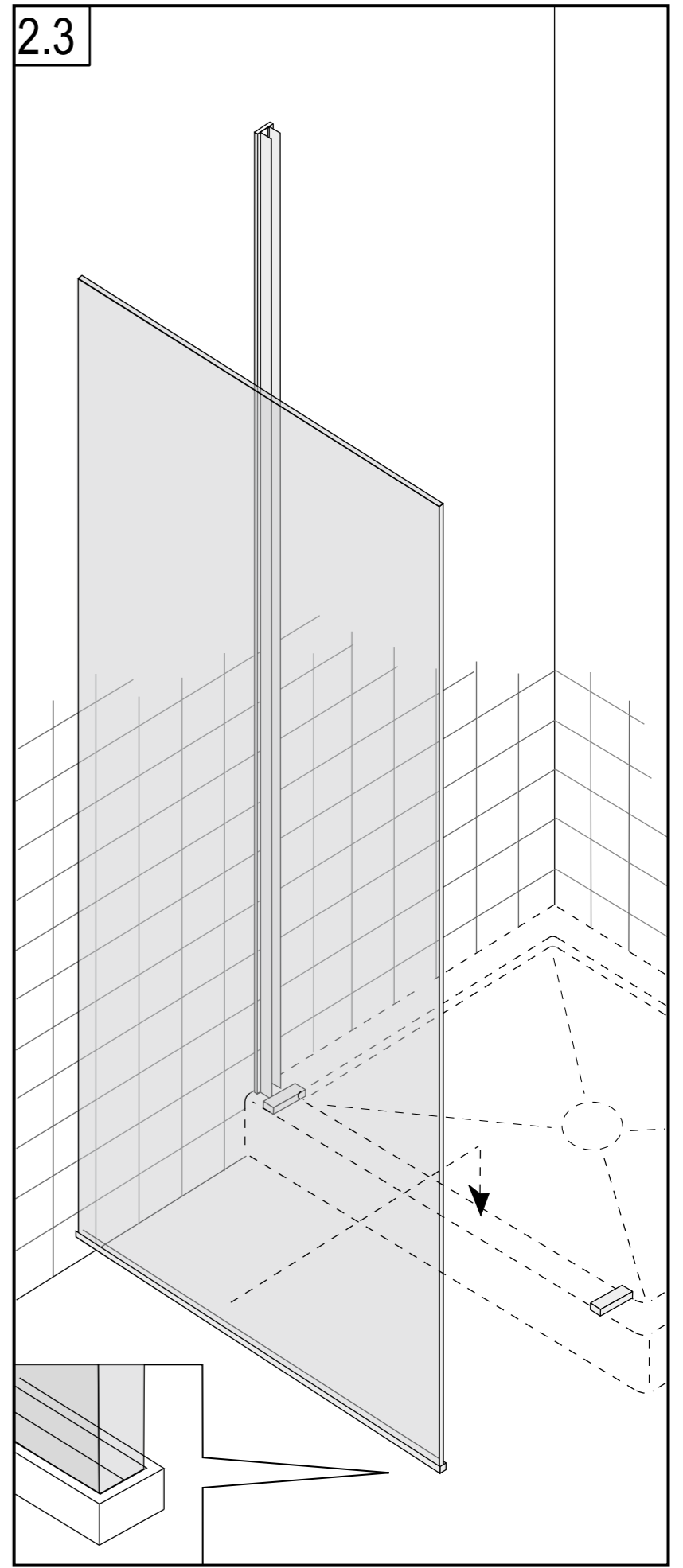
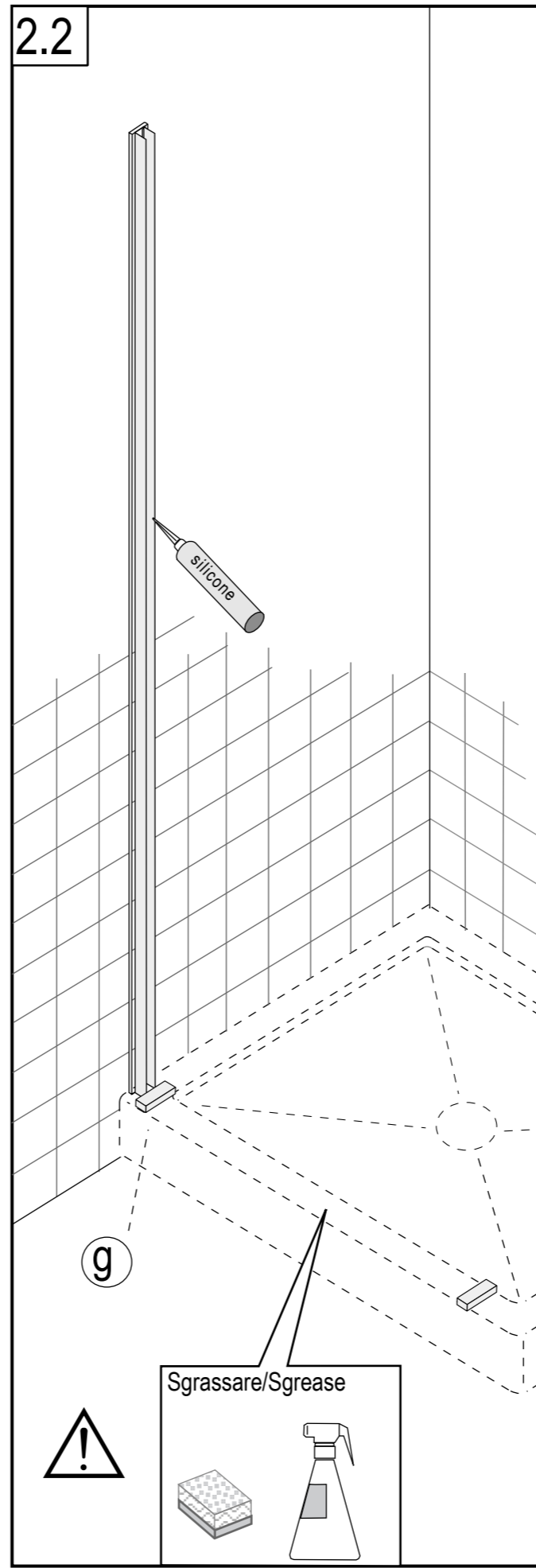
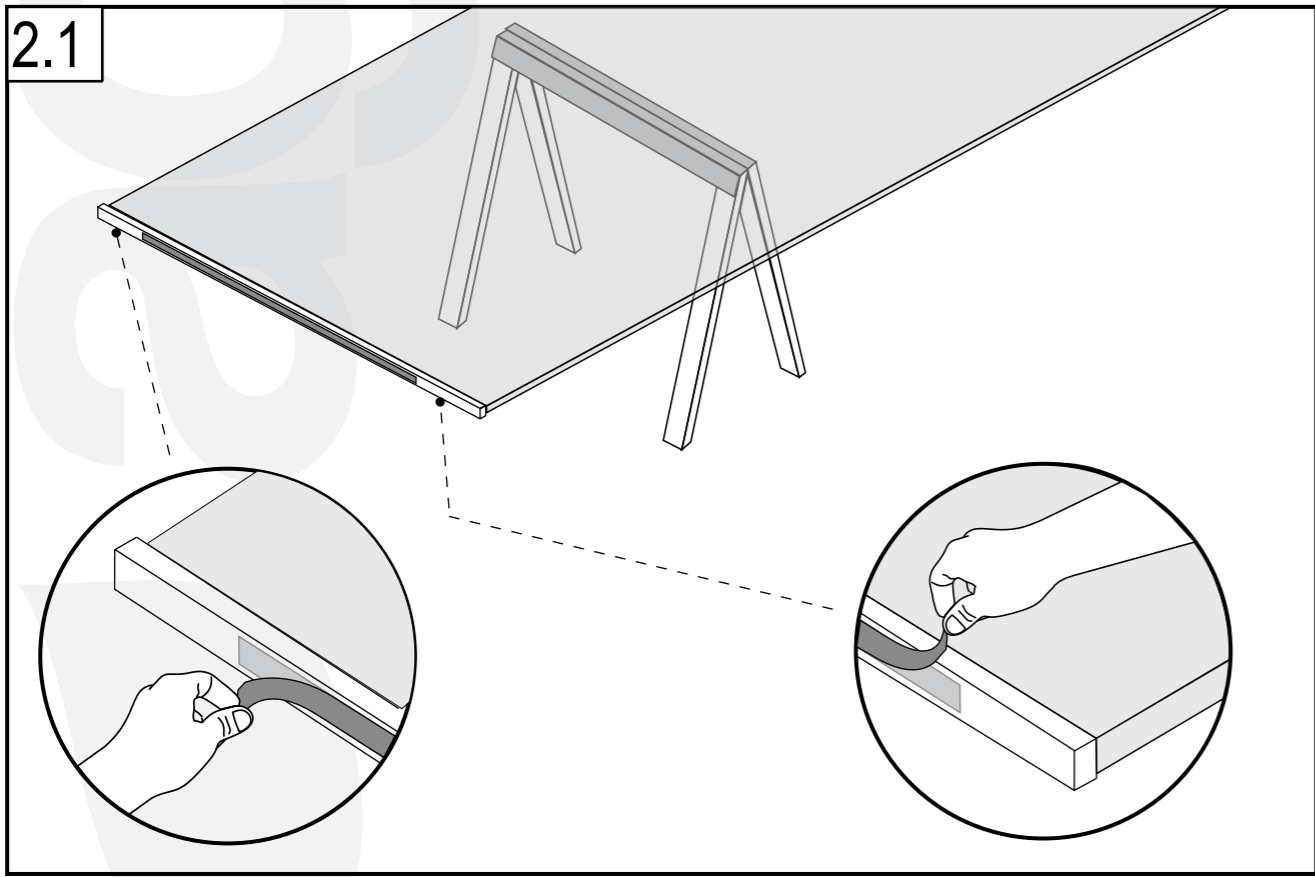
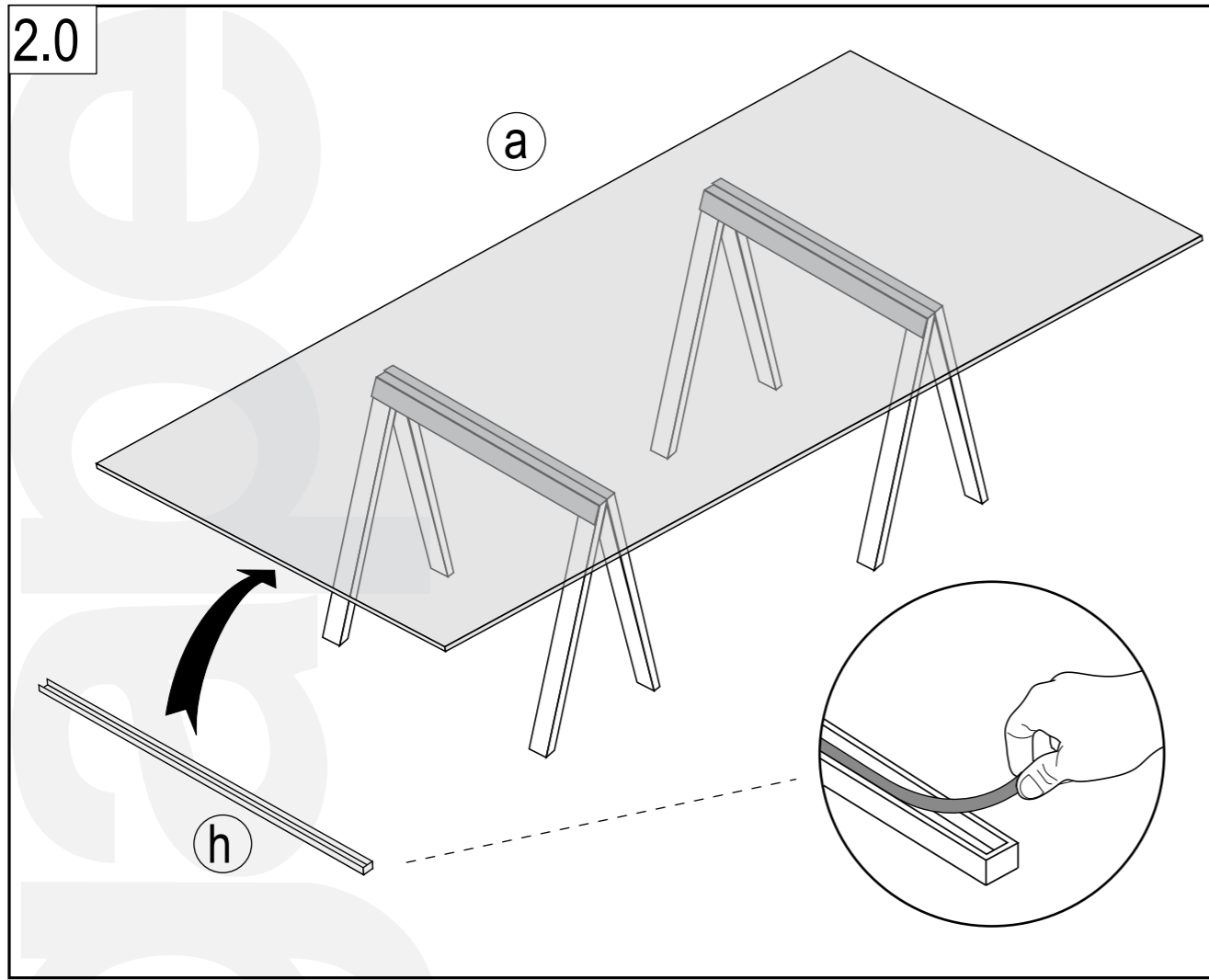

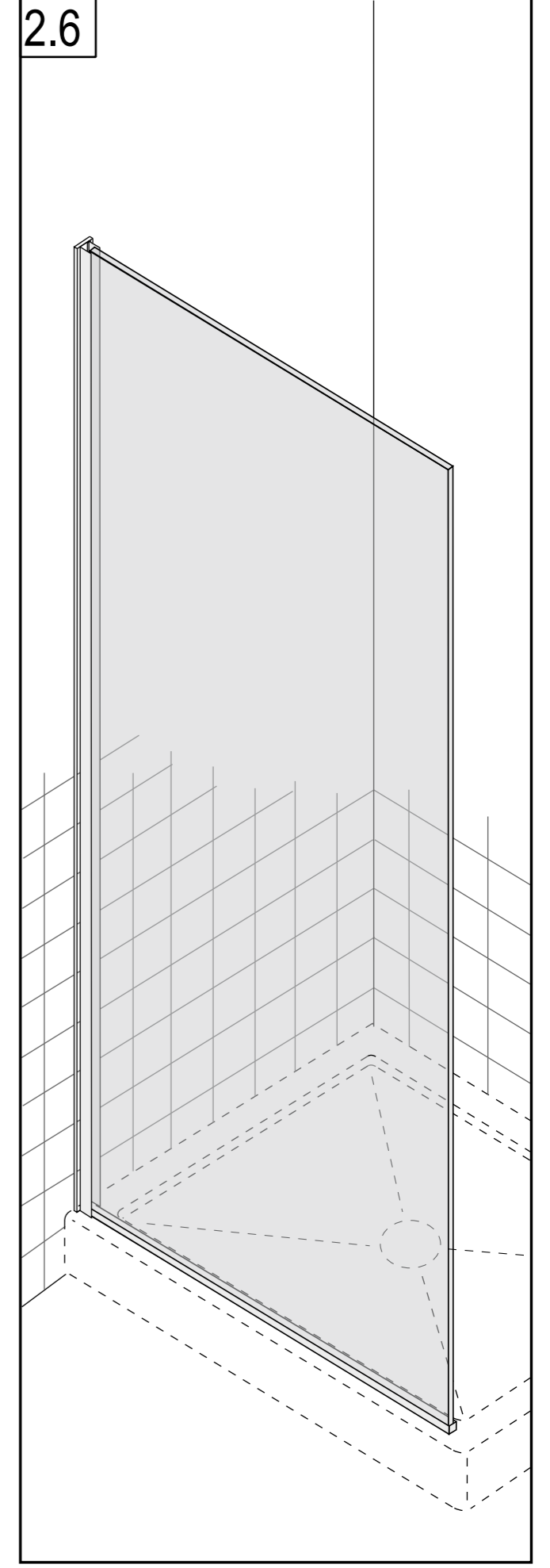
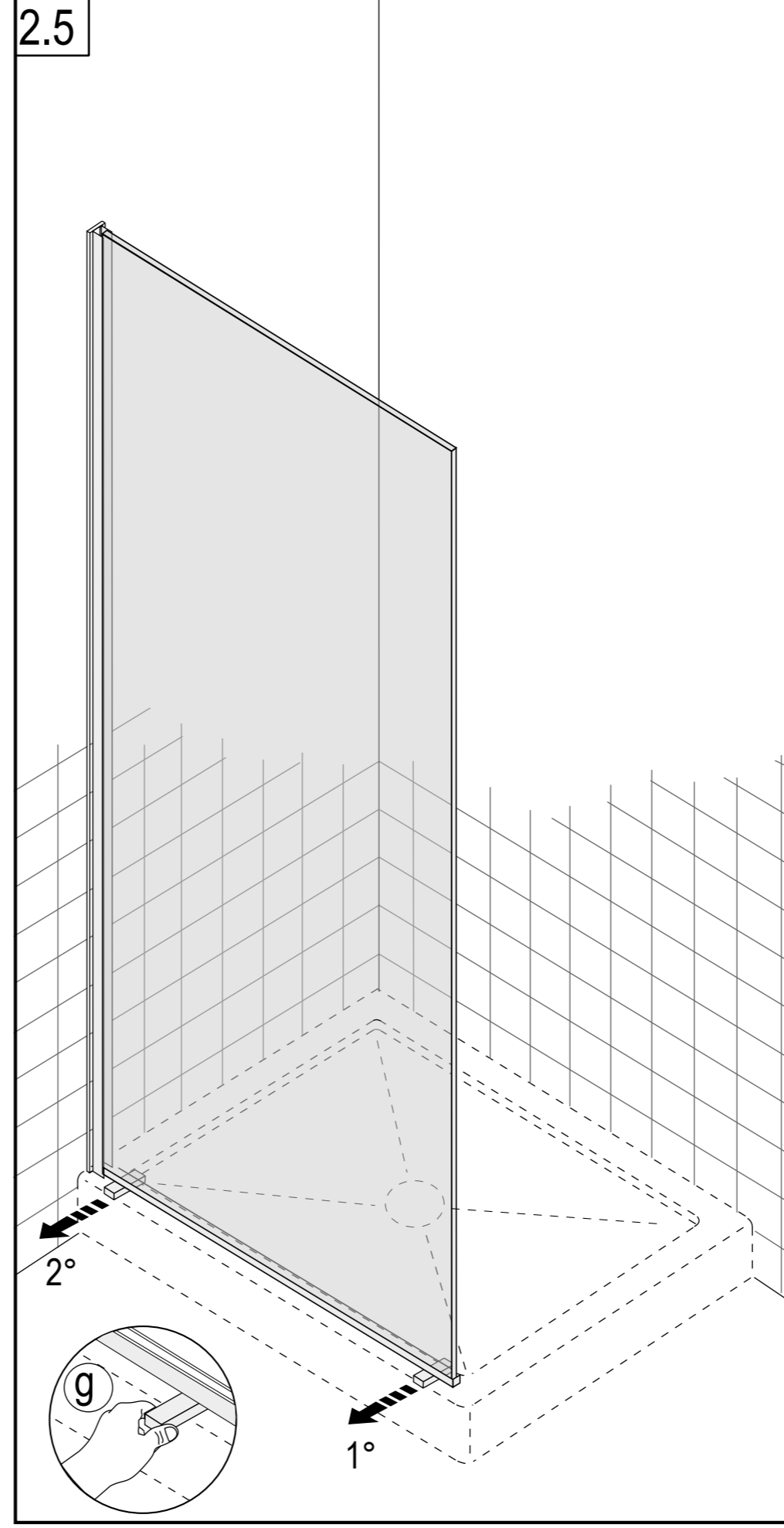
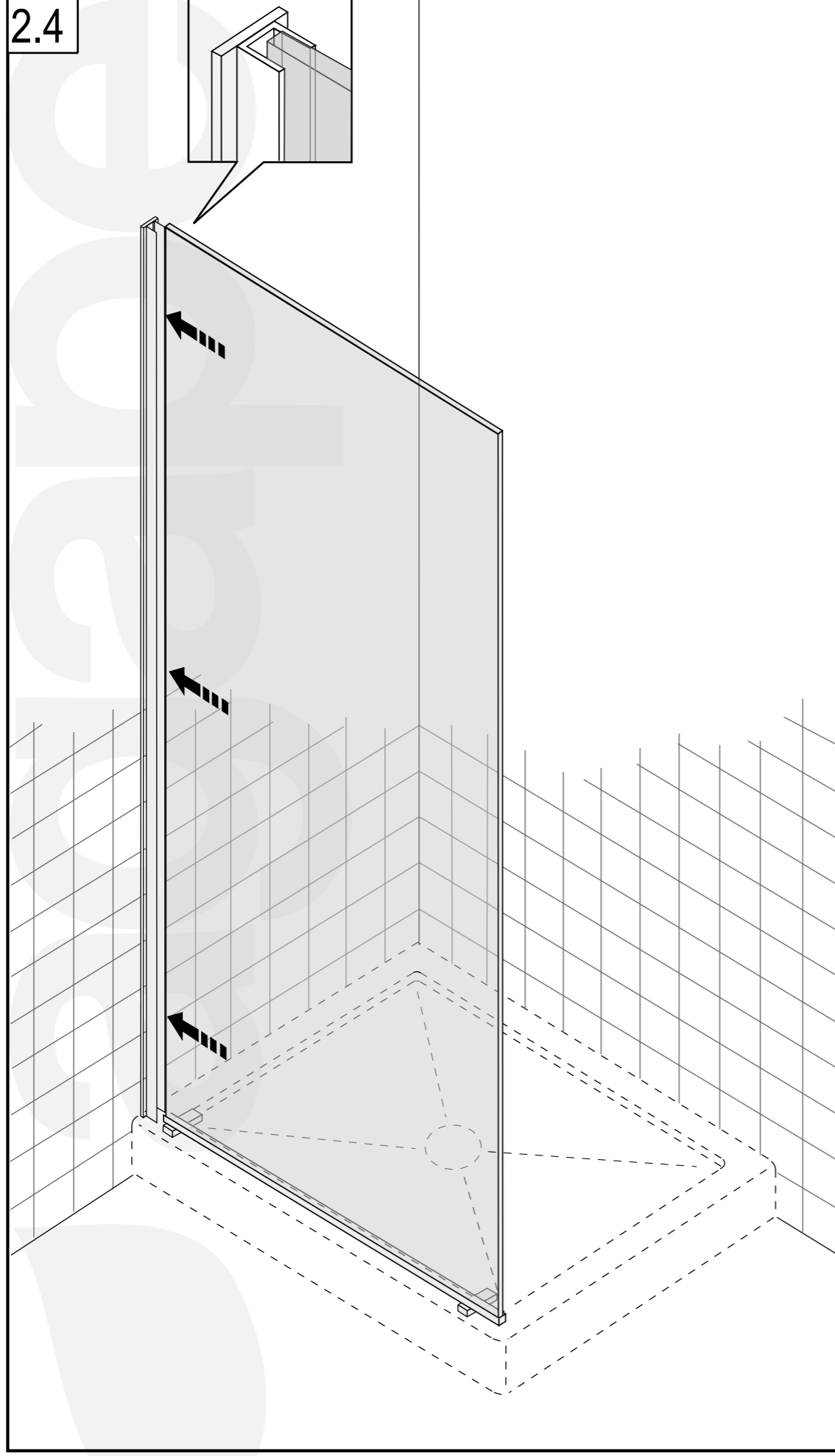

3.0

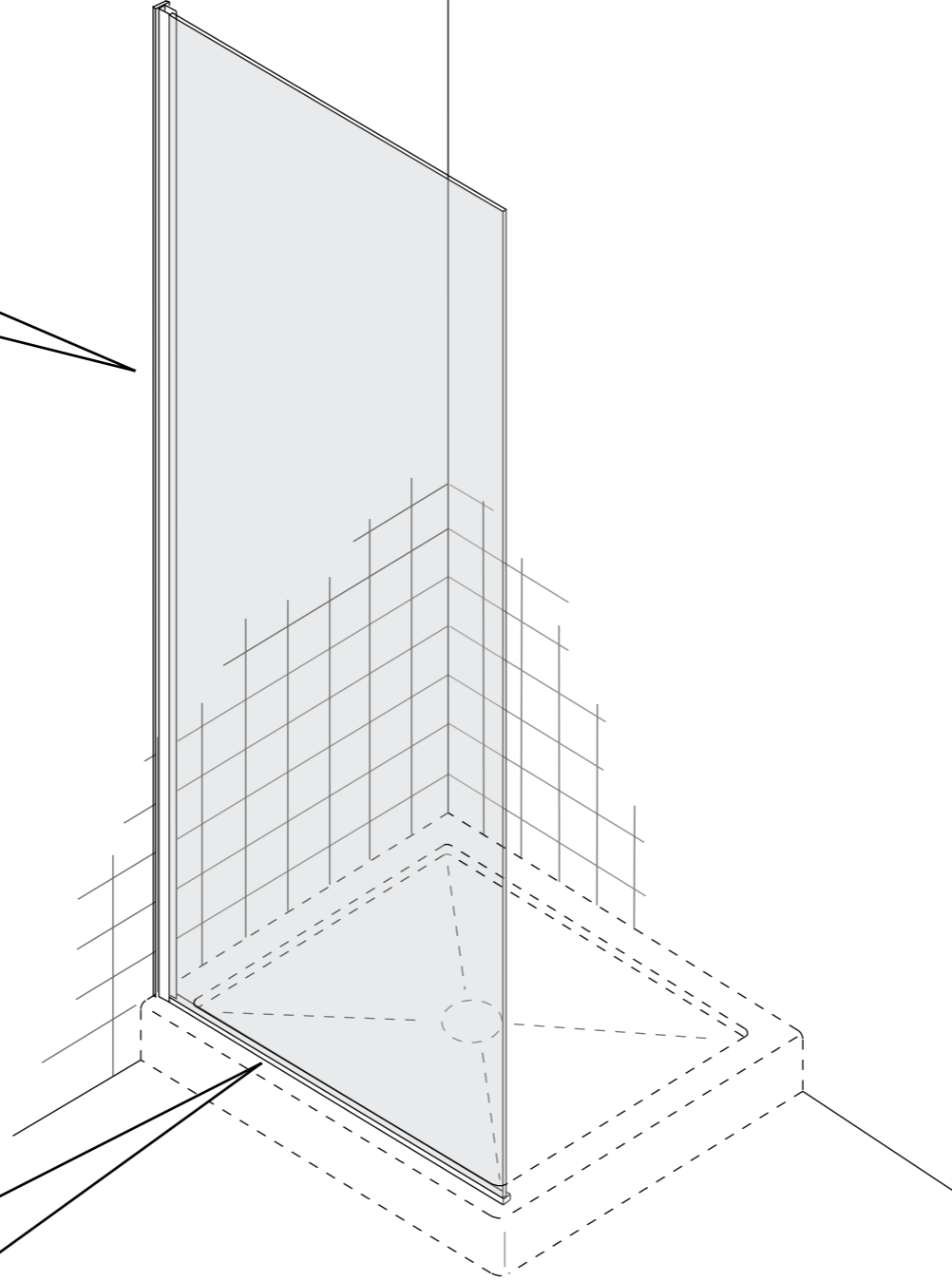
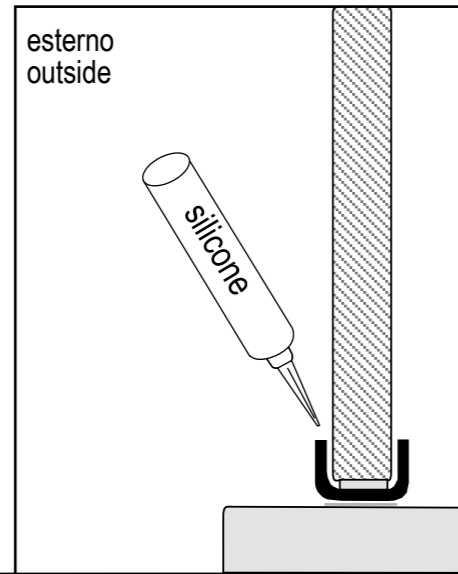
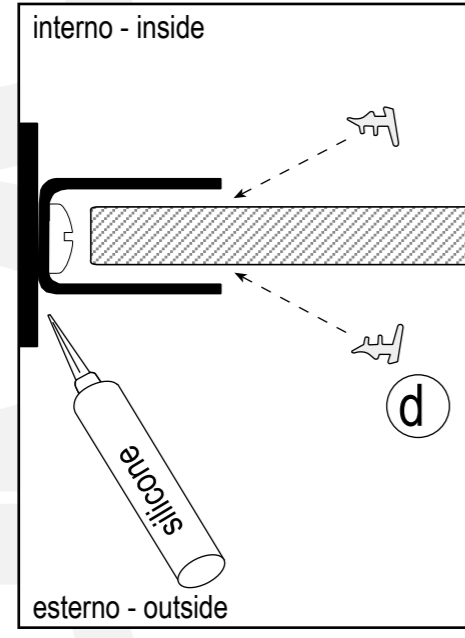

STOP 24 h.

