

"DOCCE FLAT D" mod. XG2 - Con profili esterni per installazioni su qualsiasi tipo di piatto esistente oppure su pavimento finito / With external profiles for installation on finished floor or any type of shower tray

### Soluzioni parete singola - single wall solution

istruzioni di montaggio / Instructions for installation

agape srl A. Pilentino 6 - 46037 Governolo Roncoferraro (MN)  
tel. 0376250311 - www.agapedesign.it - Viviani S. Cod.10015/1 02/2010

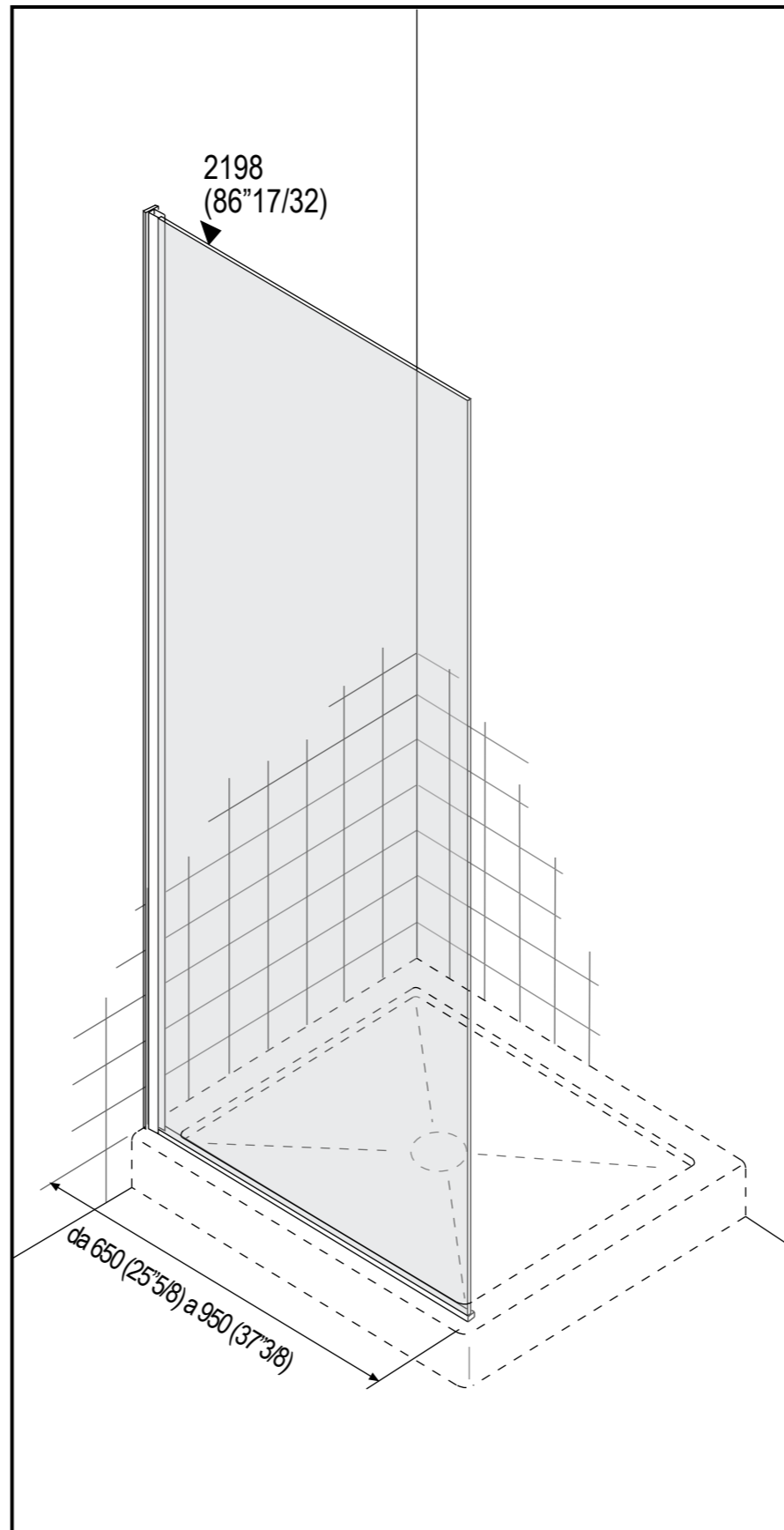
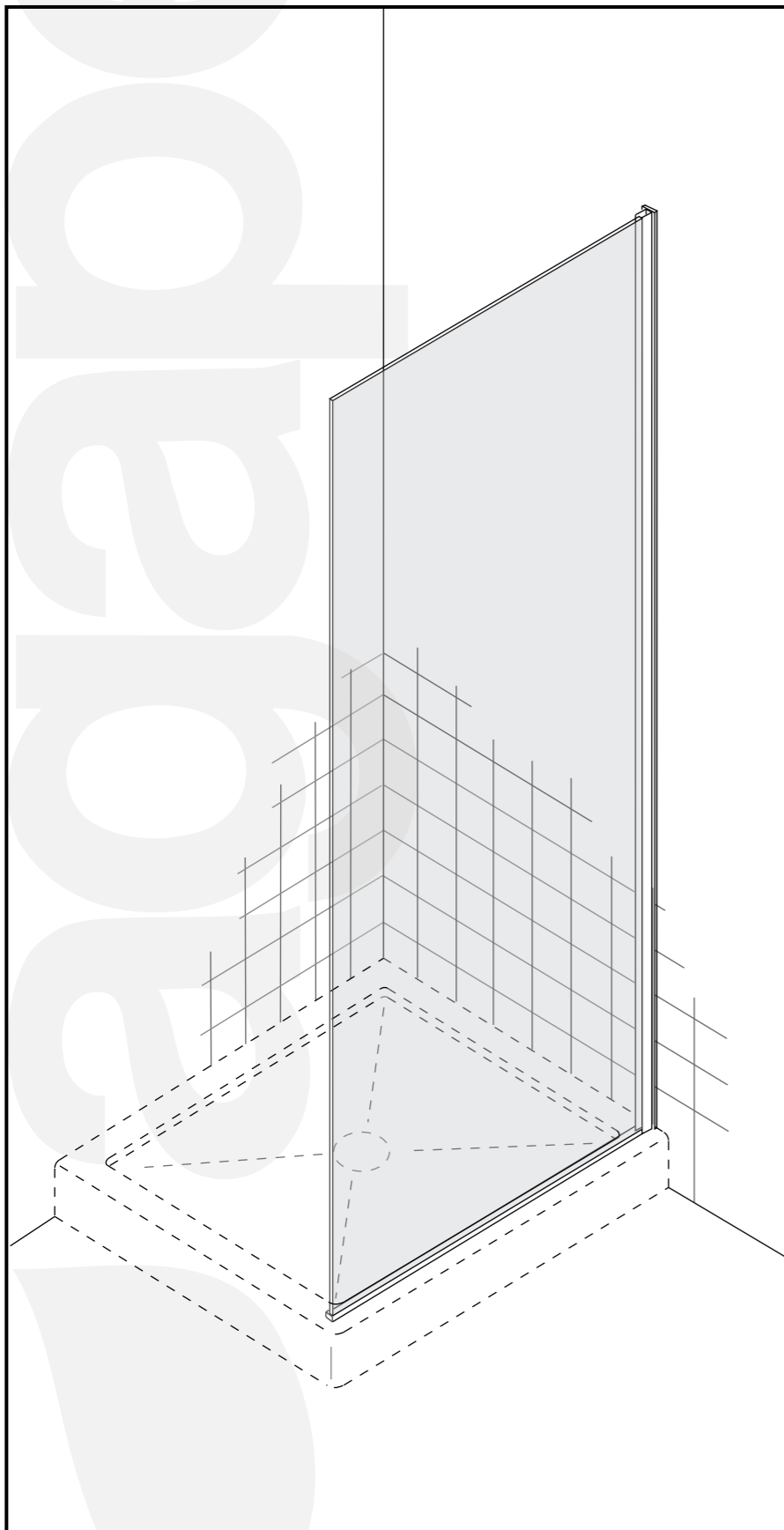

Strumenti /  
Instruments

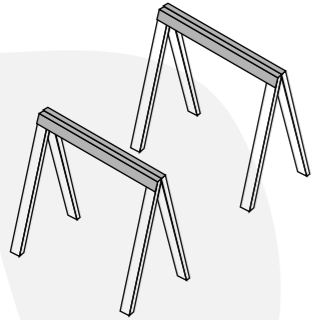
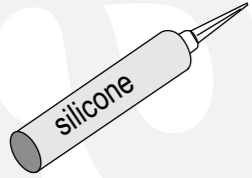
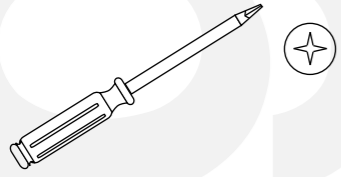
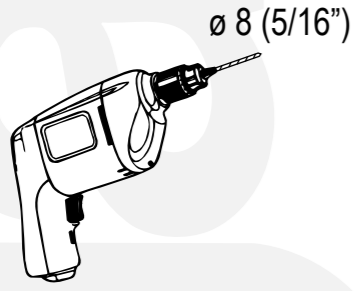
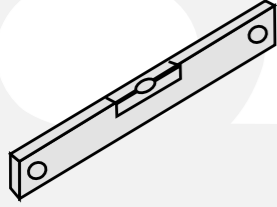

Fianco / side panel - Esploso / pre - assembled



(a) n°1



(b) n°1

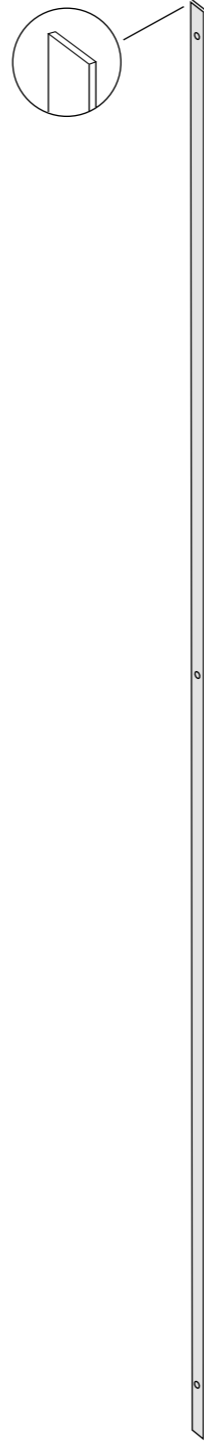

(c) n°1



(d) n°2

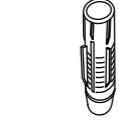

(e) n°3

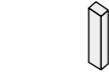

(g) n°2

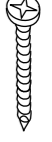

(f) n°3

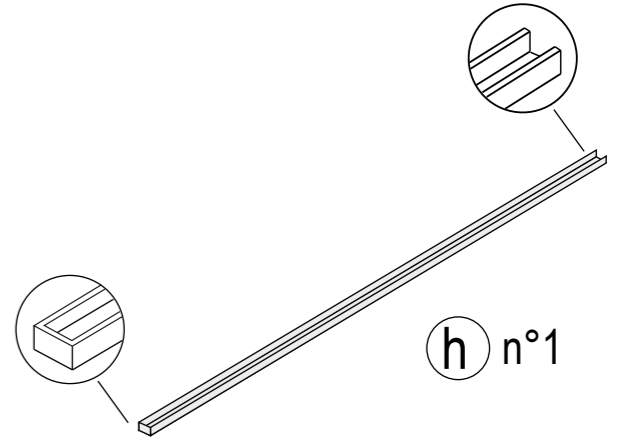

(h) n°1

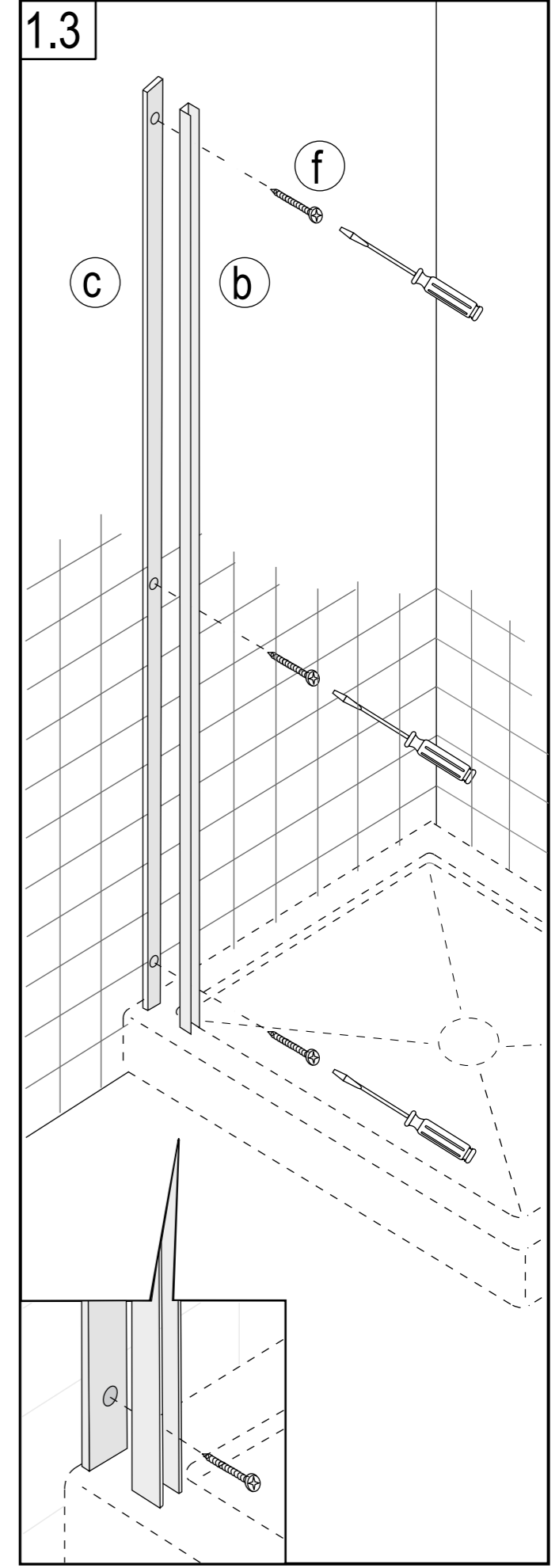
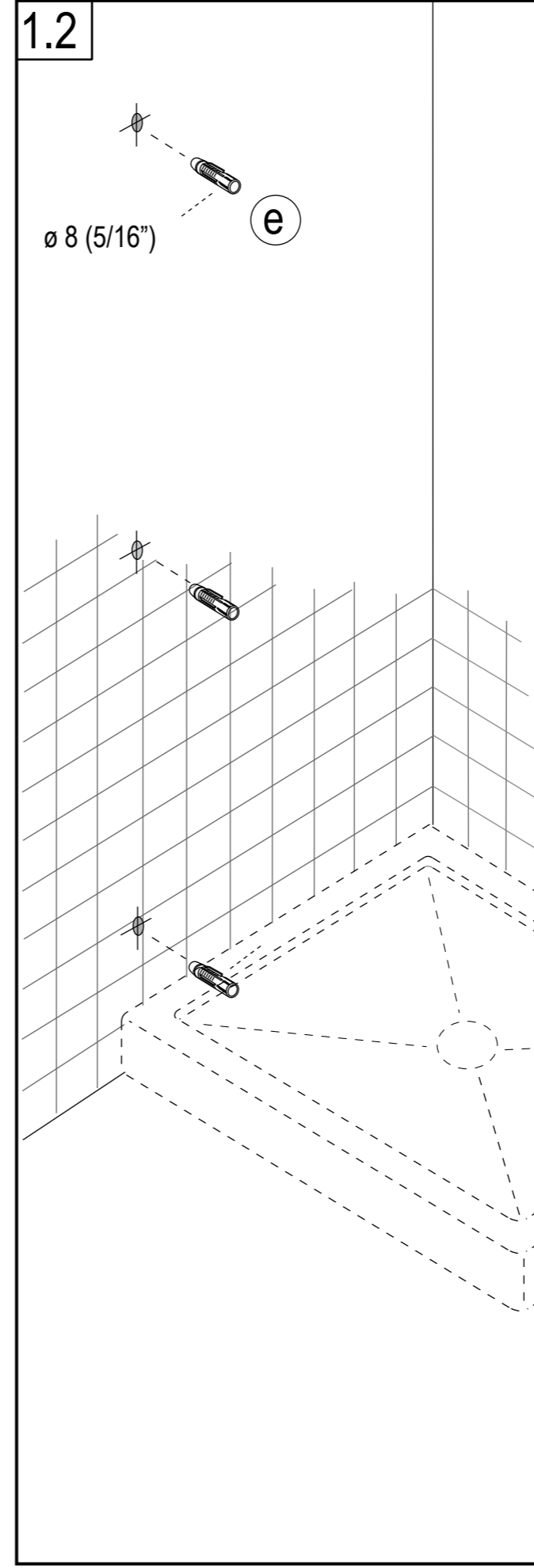
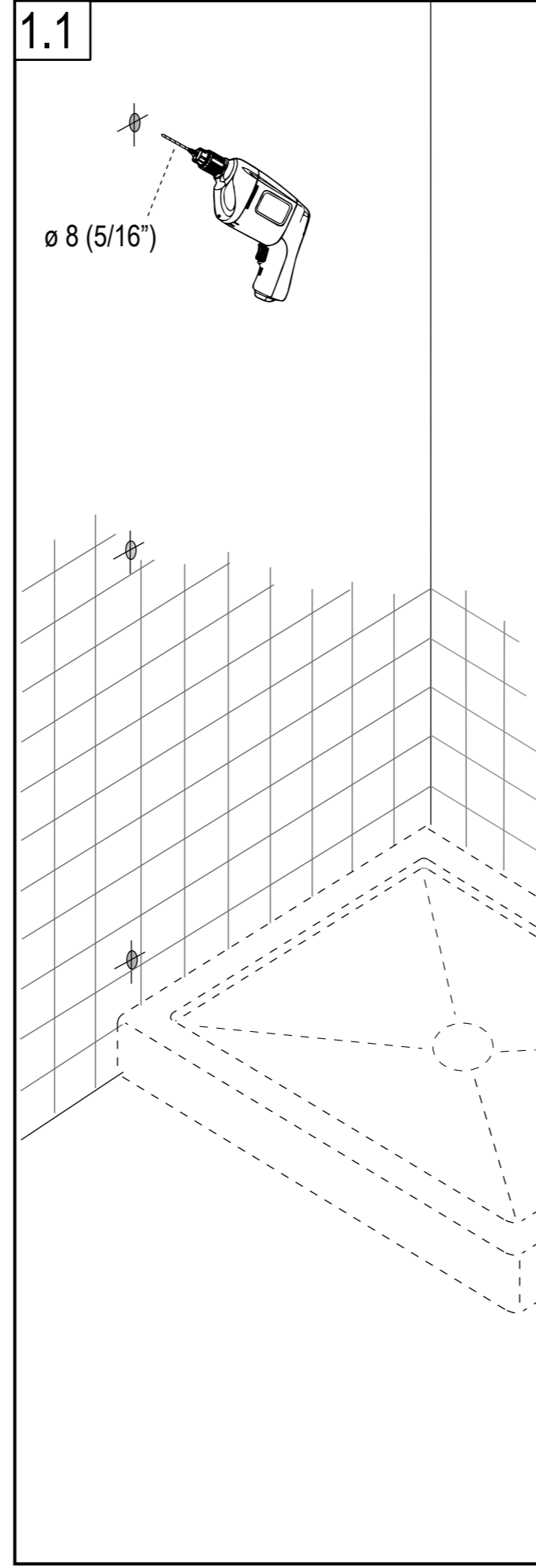
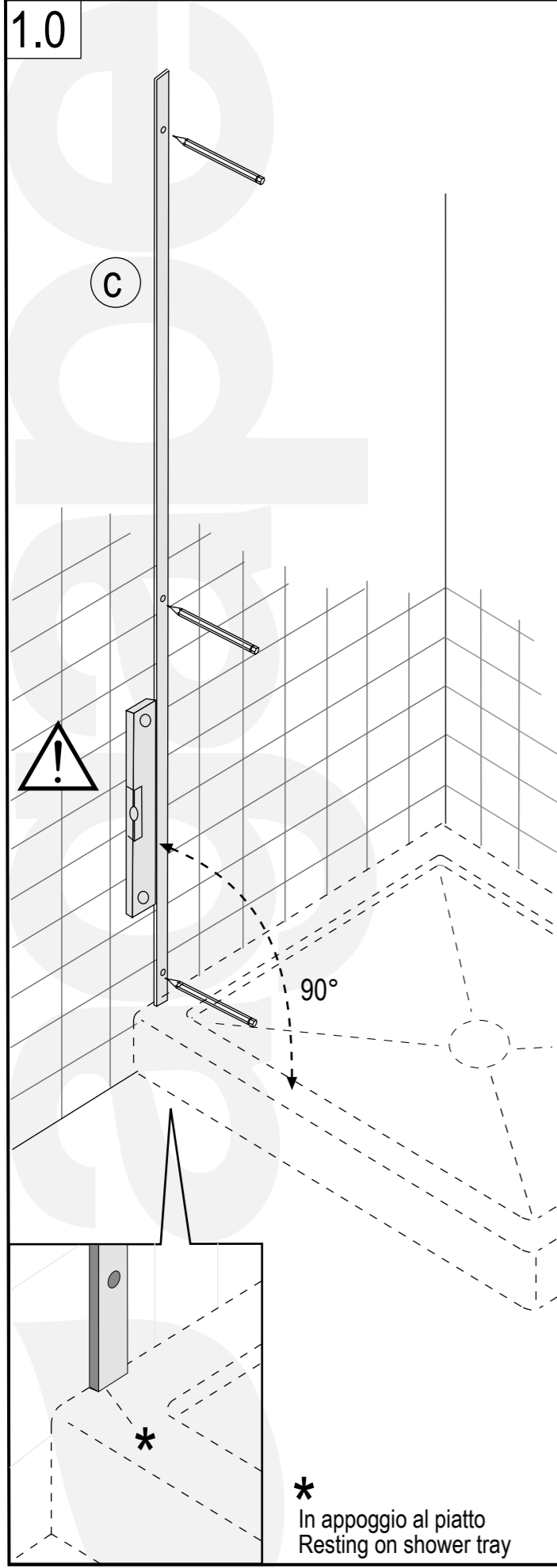

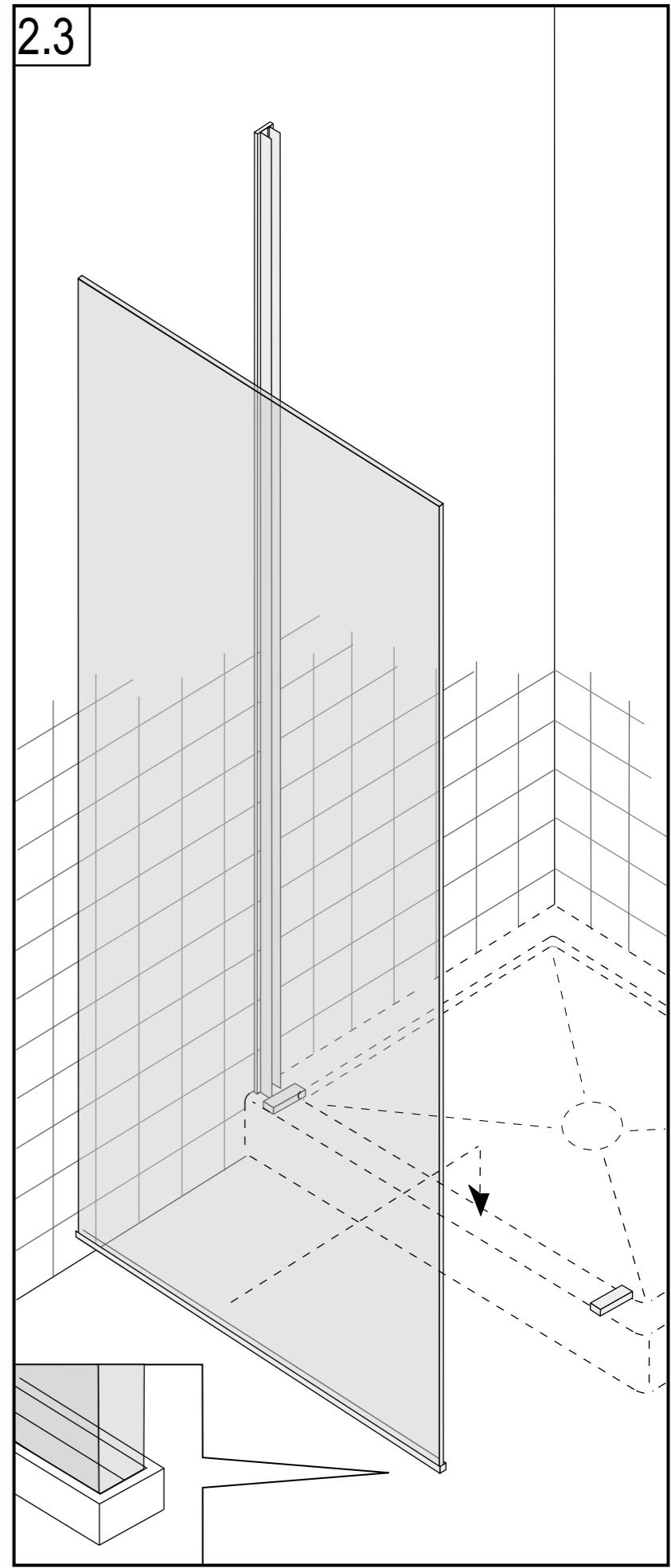
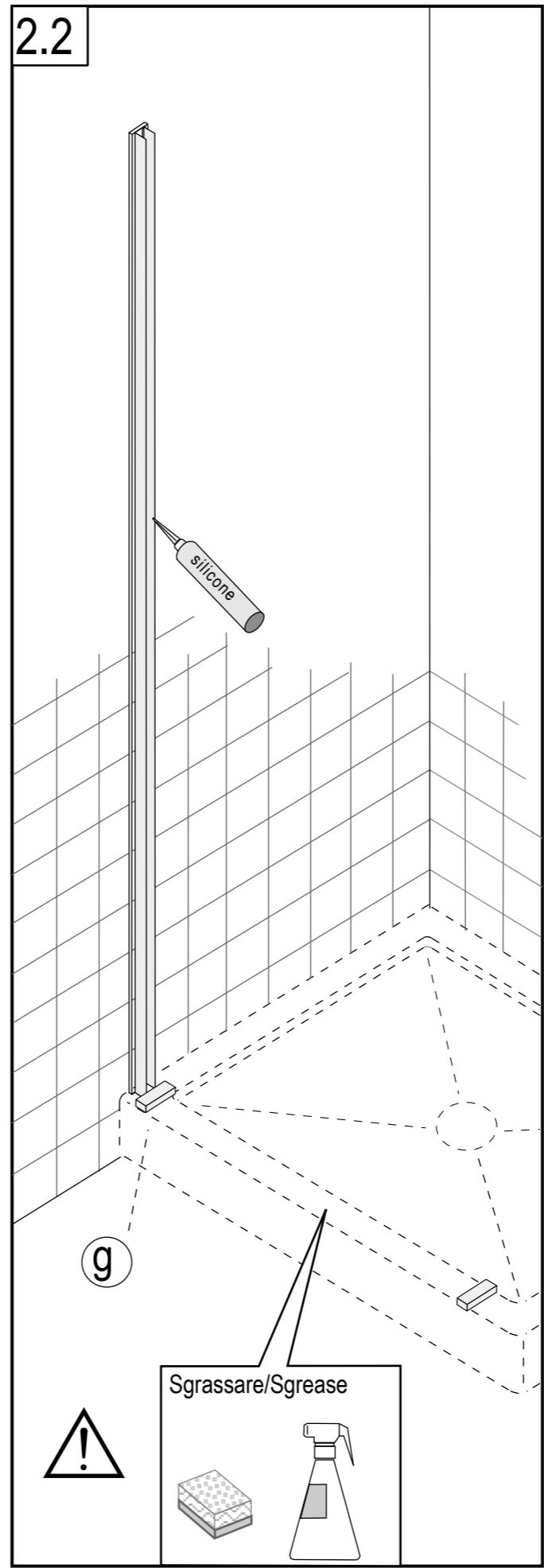
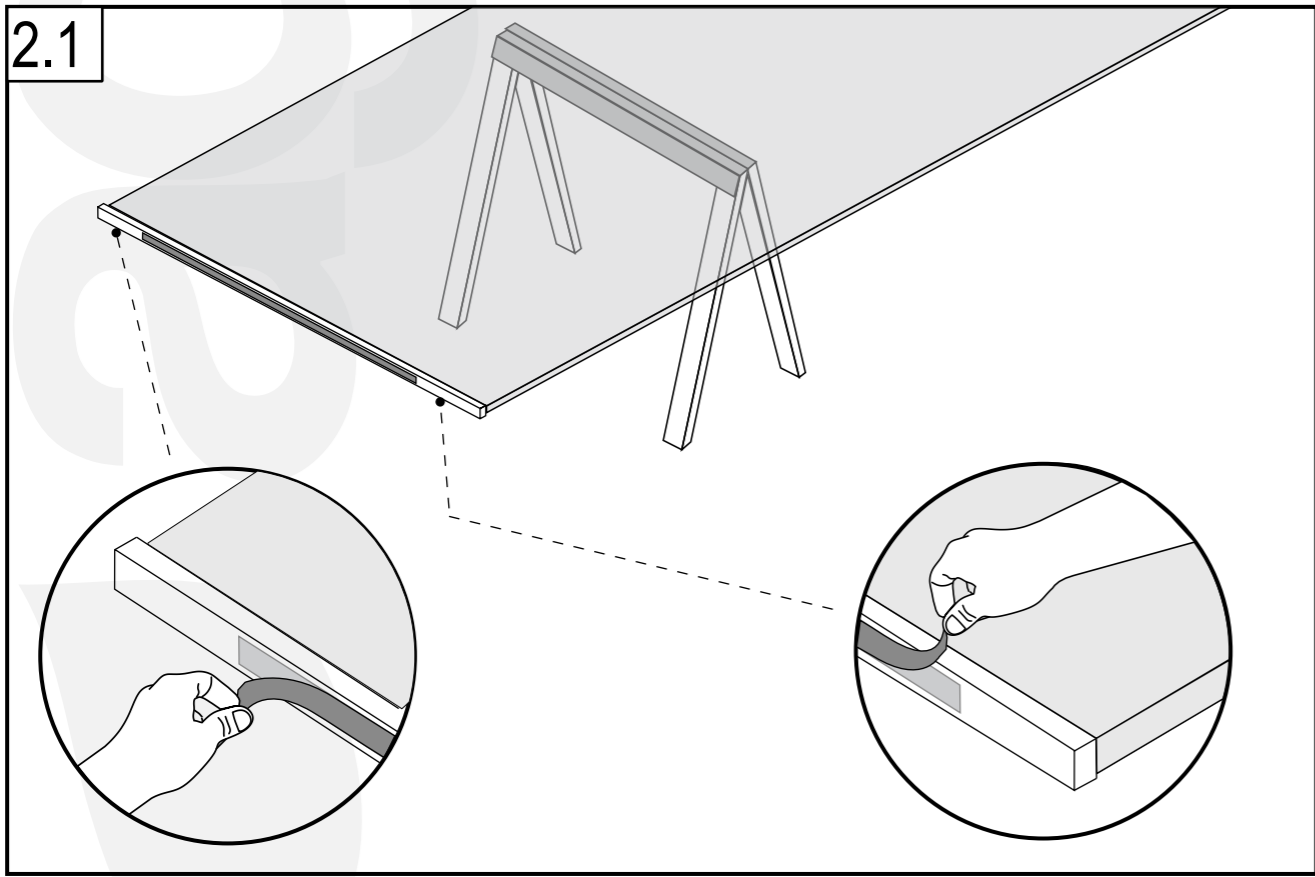
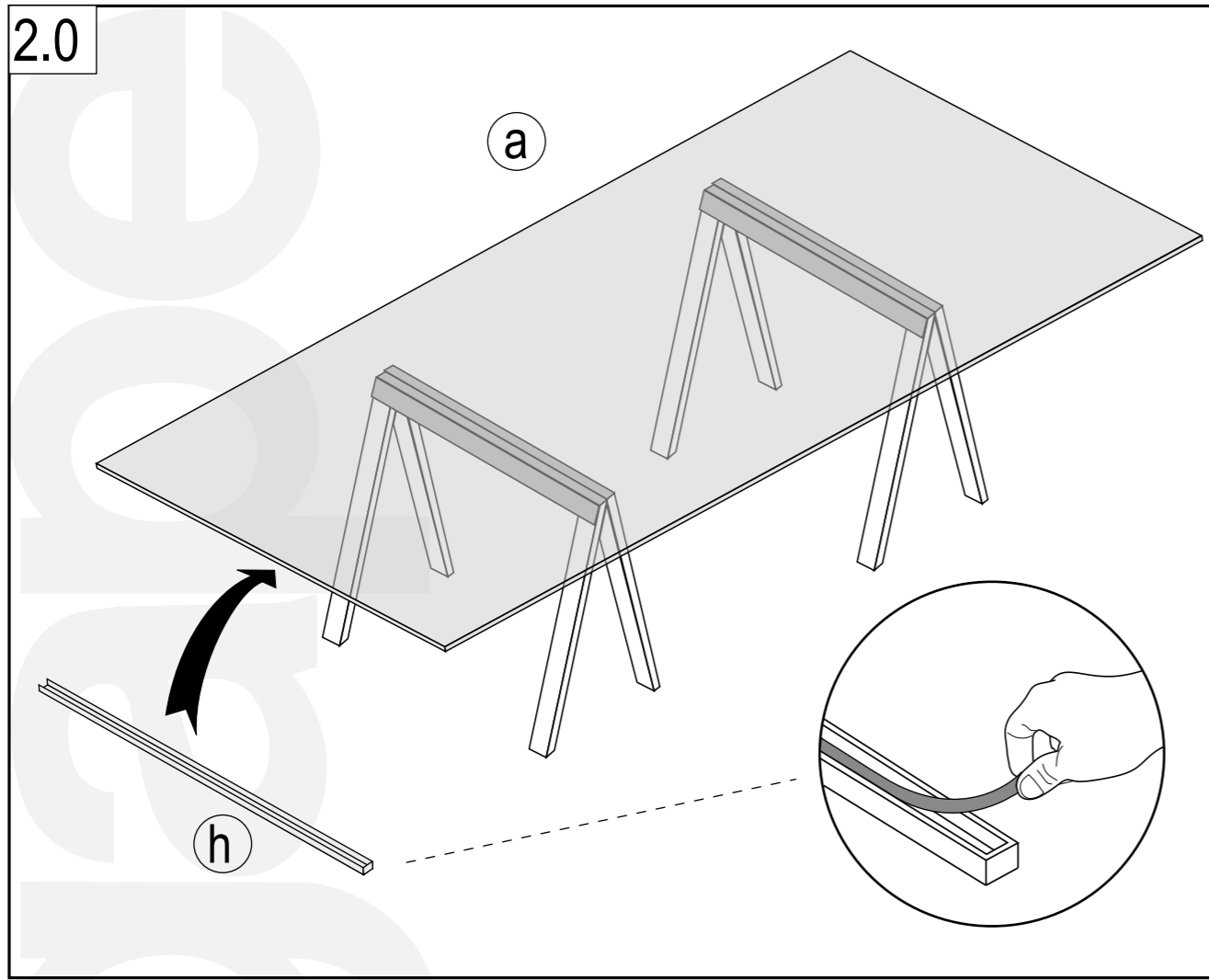

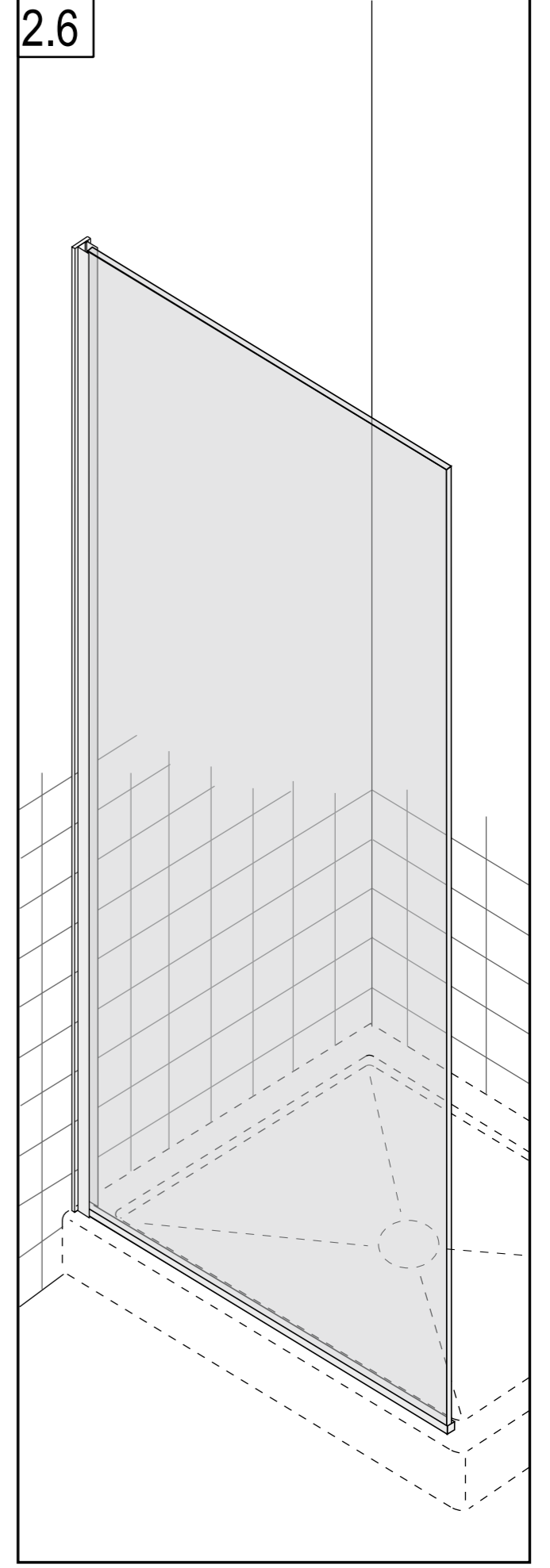
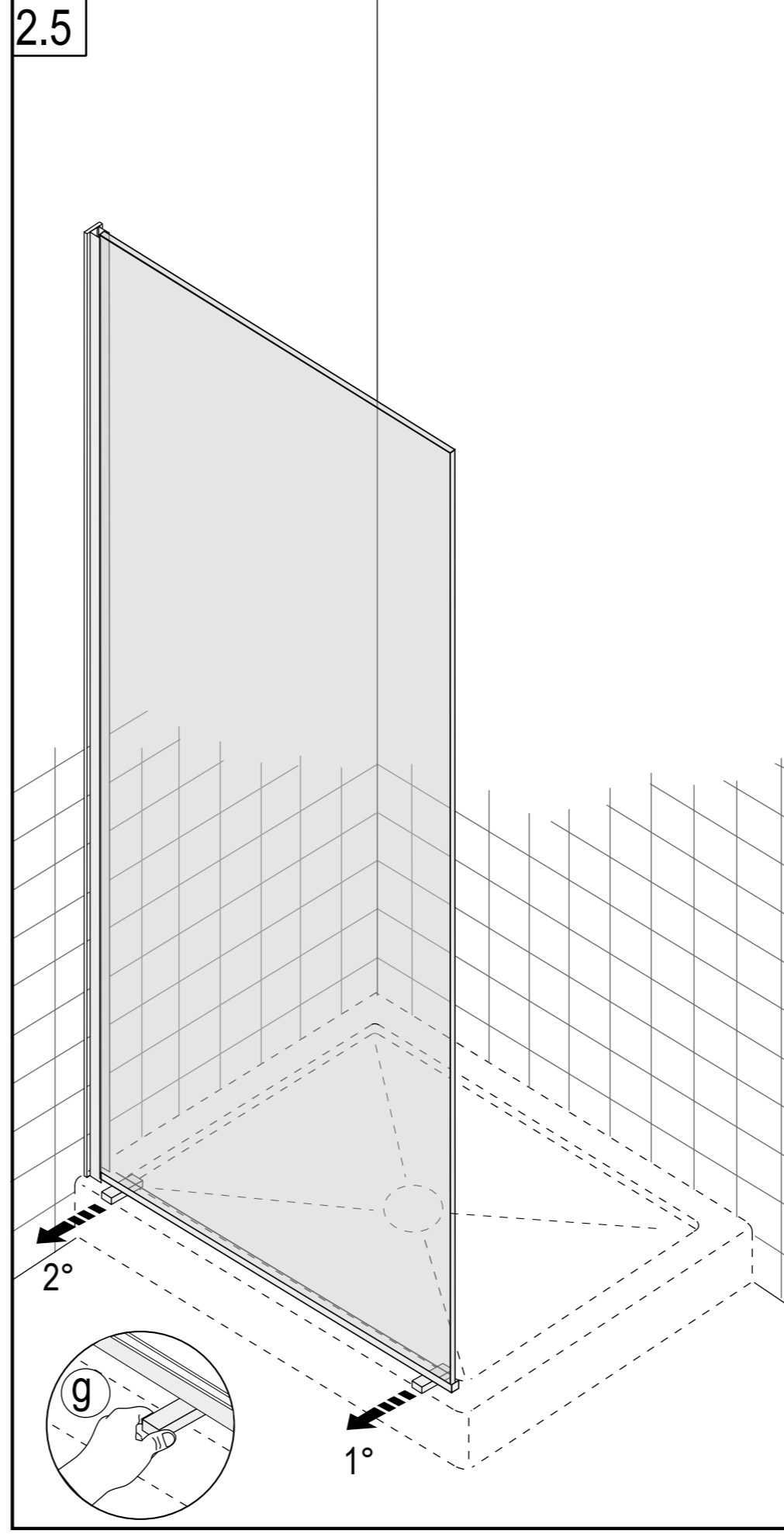
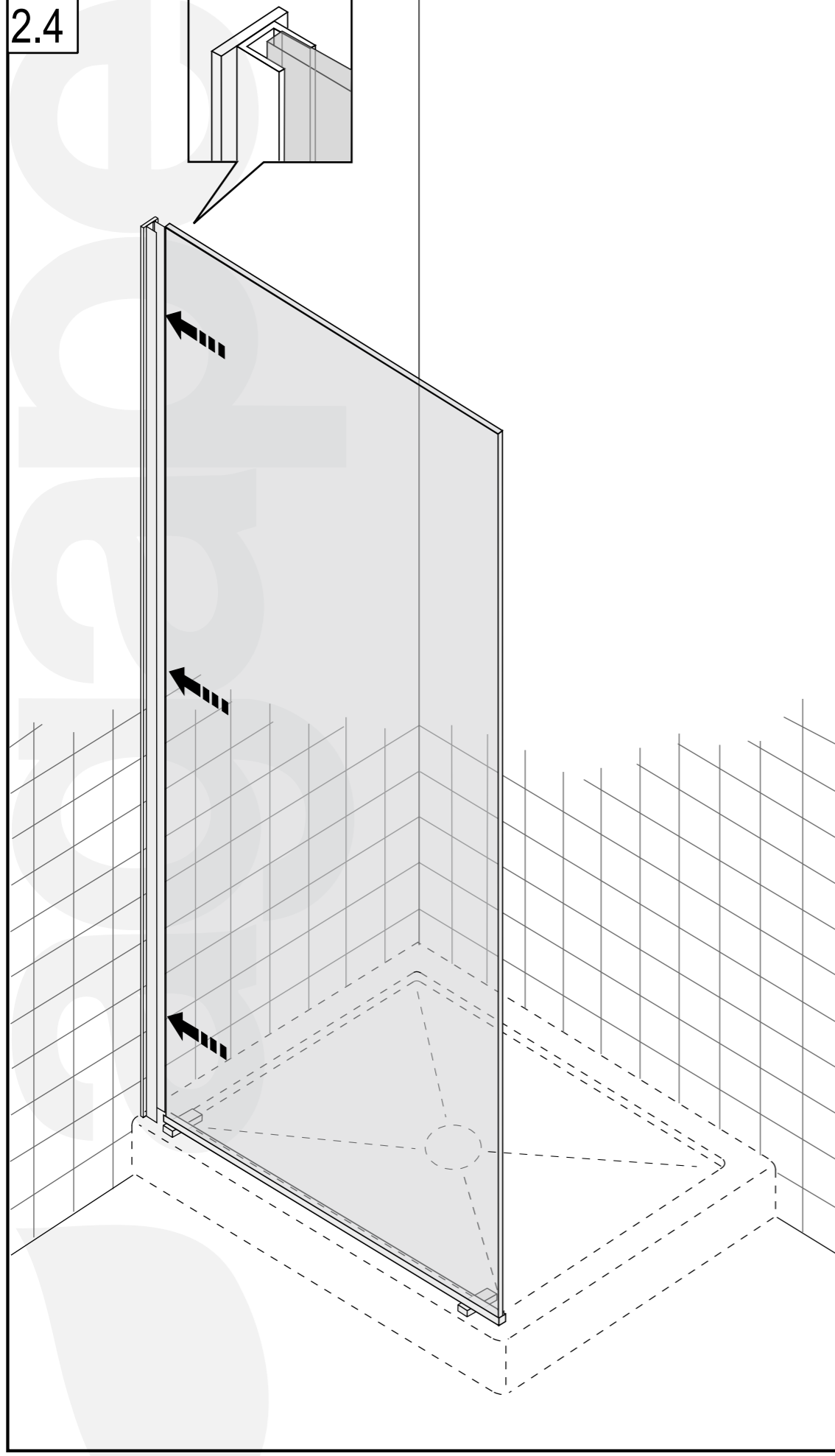

3.0

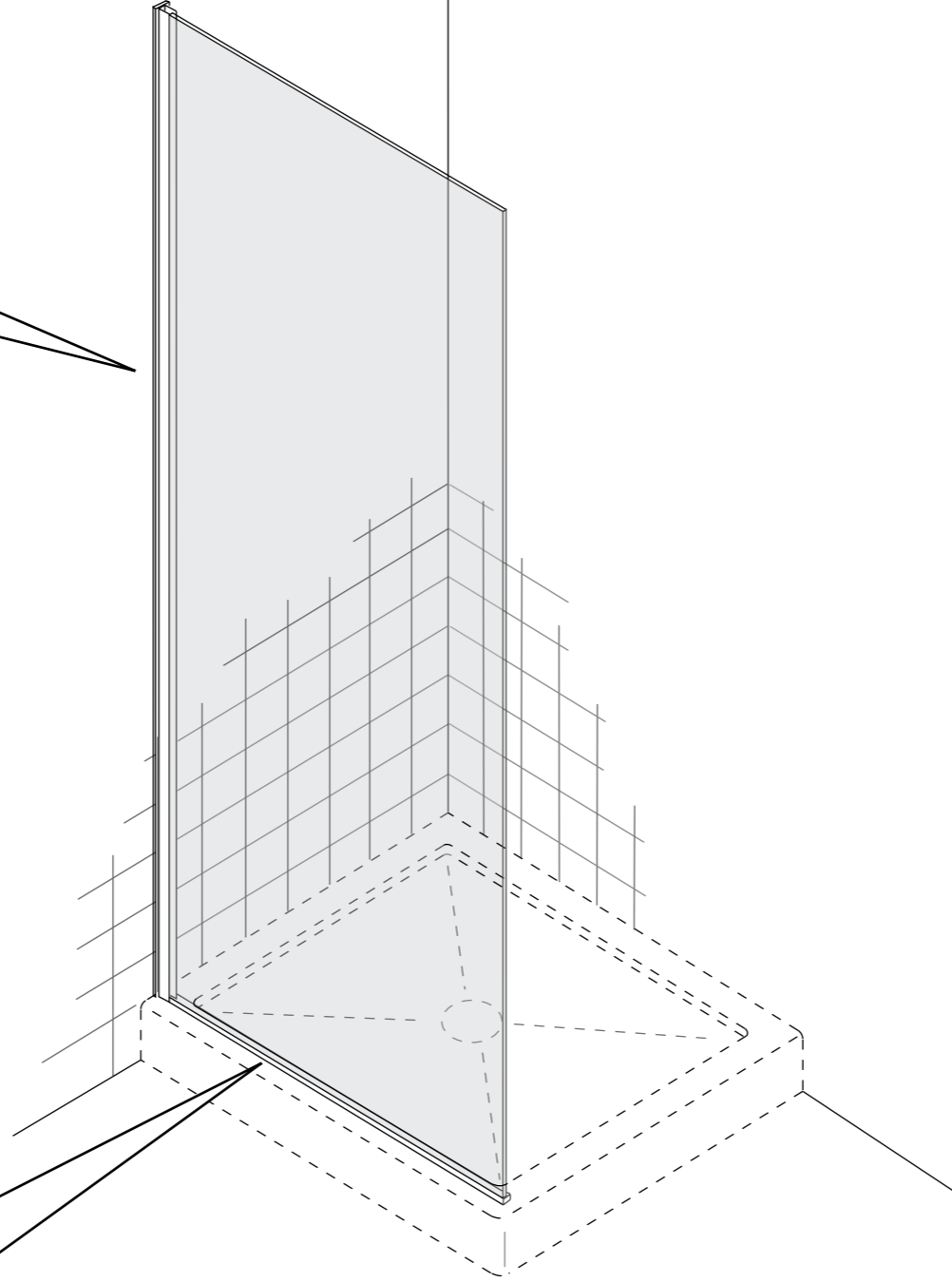
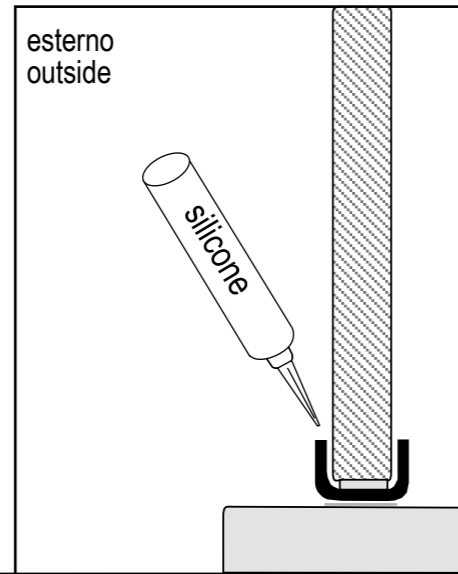
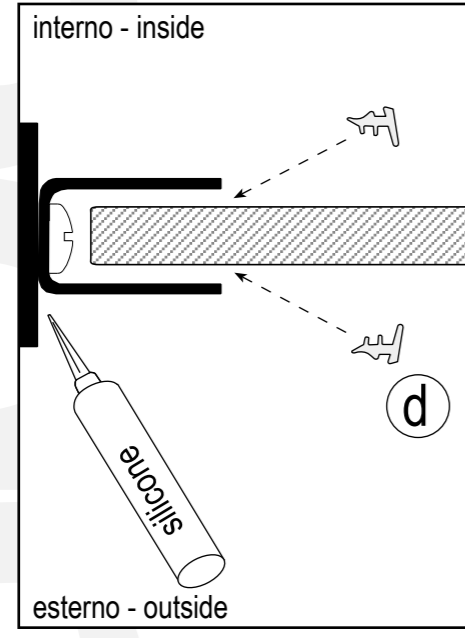

STOP 24 h.

